



INSTALLATION GUIDE



For questions, call ASCEND Customer Service at 800-922-6009 or go online at ASCENDCompositeCladding.com.

These installation instructions pertain to the ASCEND 7" plank, ASCEND 12" Board & Batten, and typical cladding accessories used in a home siding installation.

IMPORTANT: FAILURE TO FOLLOW ASCEND WRITTEN INSTALLATION INSTRUCTIONS AND COMPLY WITH APPLICABLE BUILDING CODES MAY VIOLATE LOCAL LAWS AND AFFECT CLADDING PERFORMANCE AND WARRANTY COVERAGE.

TABLE OF CONTENTS

General Information	3
Safety Precautions	3
Storage	3
Handling Instructions	3
Fastener Specifications	3
Wall Preparation	4
New Construction	4
Remodel	4
Furring Applications	4
Fastener Requirements	5
Fastening Procedure	5
Accessories Installation	6-8
Starter Strip	6
Inside and Outside Corner Posts	6
Overlapping Corner Posts	7
J-Channel	7-8
Cutting Instructions	8
ASCEND 7" Plank Installation	8-11
Fastening Procedure	9
Overlapping Planks	9
Installation Around Obstacles	10-11
Finishing Top of Walls	11
Last Course Installed Horizontally in Receiving Channel at the Eaves	11
Gable Installation	11
Masonry to ASCEND Transition	11
ASCEND 12" Board & Batten Instructions	12-15
Board & Batten Layout	12
Calculating a Balanced Appearance – Wall	12
Calculating a Balanced Appearance – Gable	13
Cutting Board & Batten Panels	13
Board & Batten Accessories Installation	14
Board & Batten Installation – Wall and Gable	14
Using Batten Strip	15
Transitions	15
H-Trim Installation	16-17
Horizontal	16
Vertical	17
Cellular PVC Trim Installation	18-20
General Information	18
Transporting and Storing	18
Cutting	18
Specialty Recommendations	21
Shutter Installation	21
Attachment of Other Products	21
Replacing a Damaged Piece	22-25
ASCEND 7" Plank	22-23
ASCEND 12" Board & Batten	24-25
Notes	26-27

GENERAL INFORMATION

- Check local building codes before installation.
 - Cladding should be installed over a sheathing that provides a smooth, flat surface.
 - Make sure the substrate meets requirements for a weather-resistant barrier system, including a water resistive barrier and proper flashing around windows, doors, other openings and corners.
- DO NOT install directly over studs.
- DO NOT hard nail.
- DO NOT install ASCEND in temperatures below -5°F.
- DO NOT rest ladders against panels. Suggest using scaffolding.
- ASCEND 7" plank must maintain a 3/8" clearance between cladding and all receiving channels.
- Ensure 1/4" clearance between Board & Batten panel and top accessory channel.
- Ensure 1/2" clearance between Board & Batten panel and bottom channel.
- ASCEND 7" plank is for horizontal applications only.
- ASCEND 12" Board & Batten is for vertical applications only.
- All cladding accessories must have a minimum pocket depth of 3/4" and accommodate 3/4" projection.
- All overlaps must have a field cut prior to installation. The cladding edge of the under plank must be cut flush to nail hem notch or beyond before being overlapped with the next plank.
 - **ASCEND 12" Board and Batten cannot be overlapped.**
- Inspect cladding for any breakage, foreign objects, surface defects, color consistency and correctness. DO NOT install questionable product.

- **IMPORTANT:** For water management, drill minimum 3/16" diameter weep holes every 24" in the base of J-channel when installed horizontally with nail hem at top of J-channel. Leave a gap between the J-channel and any head flashing.

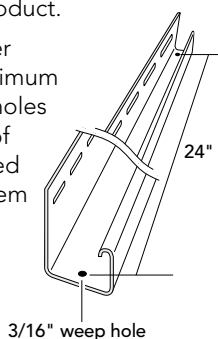

SAFETY PRECAUTIONS

- Safety goggles are always recommended for all nailing and cutting operations. As on any construction job, use proper safety equipment and follow safe construction practices.
- Cut cladding in an open, well-ventilated area.

STORAGE

- DO NOT store pallets more than four high.
- DO NOT store cartons more than five high.
- DO NOT store cartons standing up or vertically on end.
- Store away from areas where falling objects or other construction activity may inadvertently cause damage.
- Siding should be stored indoors and away from direct sources of heat and sunlight if possible.

Note: The Manufacturer is not responsible for damage caused by improper storage of the product.

- If storing outdoors at a distribution location, protective bonnet/shroud should always be kept on the cartons to prevent inadvertent surface damage.
- At the jobsite, take the following precautions when storing material:
 - ASCEND 7" Plank: Store flat and covered prior to installation.
 - ASCEND 12" Board & Batten: Store on wide side of carton and covered prior to installation. DO NOT store standing up on narrow side of carton.
 - Do not store in a location where temperatures may exceed 130°F (48.89°C) (e.g., on blacktop pavement during hot weather or under dark tarps or plastic without air circulation).
 - When transporting to a jobsite, keep cartons flat and supported along their entire length. DO NOT overhang.

HANDLING INSTRUCTIONS

- Material can be pulled from the ends of cartons; however it is recommended to cut the entire length of a carton top edge and remove material to prevent any damage at the ends of the panel. Do not cut deep into carton as you may damage material in the box. Avoid bending or damaging the panel ends.
- Avoid dragging material along the ground to avoid potential scratches at the ends of the panel.
- Ensure the product is clean when installing on the wall.

Note: The Manufacturer is not responsible for damage caused by improper handling of the product.

FASTENER SPECIFICATIONS

Use galvanized steel or other corrosion-resistant nails, staples, or screws.

- Nails: 7/16" head x 1/8" shank diameter.
- Screws: Size #8, truss or pan head, self-tapping sheet metal type.
- Staples: Minimum 16 gauge, 7/16" crown, semi-flattened to elliptical cross section.

WALL PREPARATION

ASCEND cladding serves as a supplemental rain screen, not a weather-resistant barrier and must be installed over a weather-resistant barrier system in accordance with local building code. Weather-resistant barrier systems consist of cladding, water resistive barrier, and flashed openings and penetrations. Install water-resistive barrier in accordance with the barrier manufacturer's installation instructions.

- DO NOT install ASCEND plank over metallic faced insulation/sheathing.
- Check with local code officials for building requirements in your area.

ASCEND 7" PLANK: Must be installed over a level surface with either 16" or 24" on-center framing.

ASCEND 12" BOARD & BATTEN: Must be installed over a level surface.

NEW CONSTRUCTION WALL PREPARATION:

- Apply over a rigid sheathing and weather-resistant barrier system. ASCEND cannot be installed over open studs. Where local building code requires a capillary break, see below "Furring Applications."

REMODEL WALL PREPARATION:

- Over existing wood or vinyl siding: apply fanfold, foam board or rigid sheathing over existing wood siding to provide a smooth surface. Existing substrate materials must be in good condition, DO NOT install over rot or mold.
- Removing old siding: prepare wall as described in New Construction.

Note: FOR 12" BOARD & BATTEN ONLY: Remodel installations using a non-nailable foam or fiber sheathing requires furring. See "Furring Applications" section below.

FURRING APPLICATIONS:

Wood furring is used to correct uneven walls, over masonry walls, or where local building code requires a capillary break between the wall and siding.

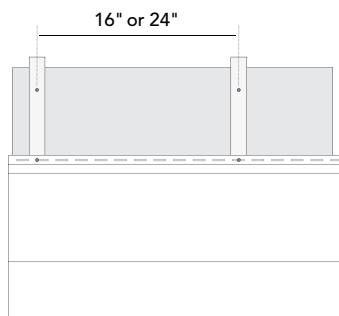

Vertical furring should be 1"x3" furring strips, spaced 16" or 24" O.C., and fastened framing members of structure.

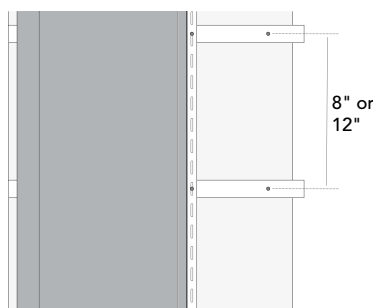

Horizontal furring should be 1"x3" furring strips, spaced 8" or 12" O.C., and fastened framing members of structure every 12".

Except for applications requiring capillary break per building code, create a flat surface by:

1. Installing foam board or rigid sheathing between furring, OR
2. Apply fanfold, foam board or rigid sheathing over furring across the width of wall (including over furring).

Measure and plan for the first overlap to land over furring. When overlaps land between furring strips for applications requiring a capillary break per building code, a 1"x3" furring strip at 1" length should be placed behind overlap for support.

ASCEND 7" PLANK

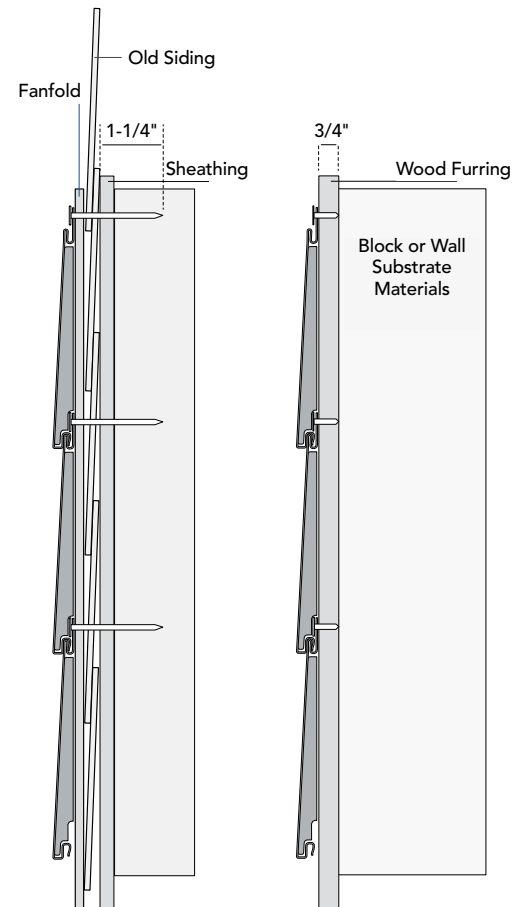
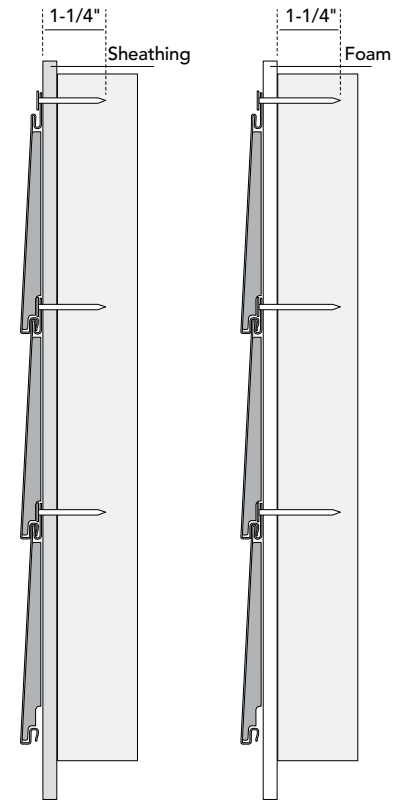

Due to varying thickness of substrate materials, appearance of materials and fastener length may not be to scale.

ASCEND 12" BOARD & BATTEN

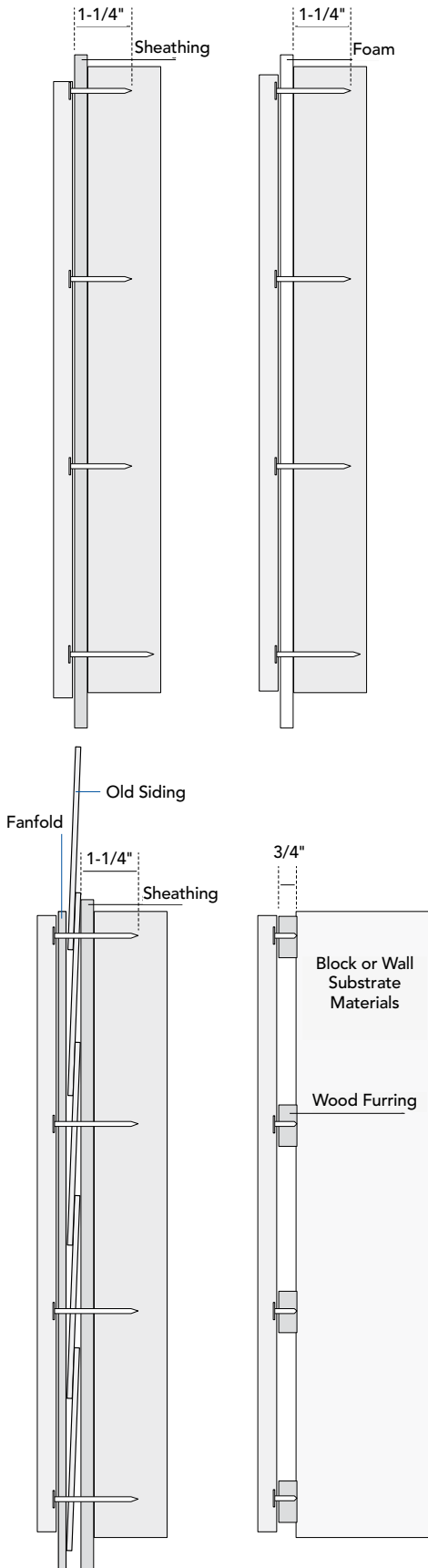

FASTENER REQUIREMENTS

- Use galvanized steel or other corrosion-resistant nails, staples or screws when installing ASCEND. See "Fastener Specifications" on page 3.
- Proper fastener penetration is minimum 1-1/4" into nailable solid material, such as wood sheathing and framing members. When fasteners penetrate non-nailable material, such as foam sheathing, the thickness of non-nailable material does not count toward the minimum 1-1/4" penetration. ASCEND may be used in furring applications with 3/4" fastener penetration.

IMPORTANT: Hang ASCEND Board & Batten panel by placing the first fastener in the uppermost part of top full slot. **DO NOT** fasten through nailing flanges of any other accessories. Place all other fasteners in center of nail slots, every 8" or 12" O.C.

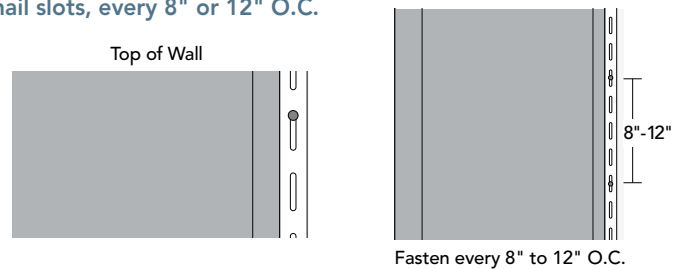

- **DO NOT** hard nail, leave 1/32" (minimum) space between fastener and nail hem.
- When using power nail guns and staplers, set and adjust air pressure ensuring 1/32" clearance between fasteners and nailing hem.

Check with ASCEND technical support for specific windload resistance for 3/4" fastener penetration into 1" x 3" wood furring.

FASTENING PROCEDURE

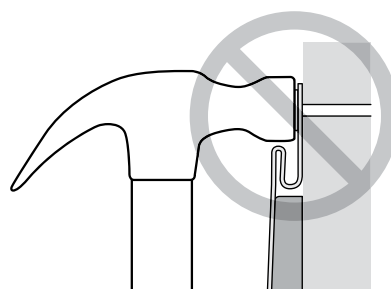

Do not drive the head of fastener tightly against the cladding and accessory nail hem.

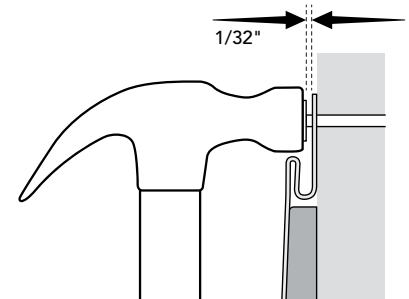

Allow 1/32" clearance between fastener head and nailing hem for expansion.

Due to varying thickness of substrate materials, appearance of materials and fastener length may not be to scale.

ASCEND ACCESSORIES INSTALLATION INSTRUCTIONS

ACCESSORIES INSTALLATION: ASCEND STARTER STRIP

- For cladding to be installed properly, in level fashion, the starter strip at the bottom must be level. Failure to install starter strips level will negatively impact subsequent courses and overlap appearance.
- There are two methods to determine position of starter strip:
 - Option 1:** Determine lowest point of the wall, measure up 1/4" less than the width of starter strip and mark on the wall.
 - Using a chalk line from the mark, go to the next corner and pull the line taut. Make sure the line is level and snap a chalk line, repeating around the entire house.
 - Option 2:** Measure down from soffit to the top of foundation and subtract 1/4" less width of starter strip.
 - Make a mark on the wall and transfer measurement to the other corner of the wall.
 - Snap a chalk line between the corners at the marks, repeating around the entire house.
- Keep ends of starter strips 1/4" apart to allow for expansion.
- Fasten every 8", center of slots, 1-1/4" penetration into studs and leave 1/32" clearance between fastener head and starter, staggering fasteners in top and bottom row of slots.
- Maintain a minimum 1/2" clearance from grade and slab concrete for cladding and accessories.

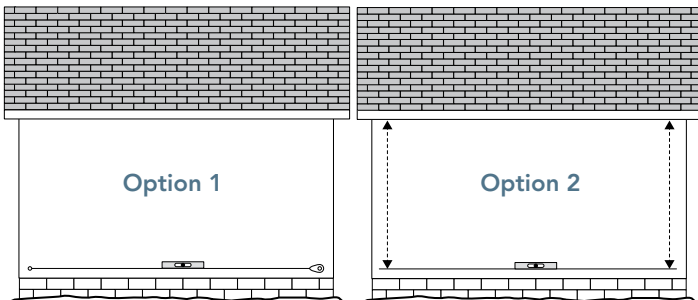
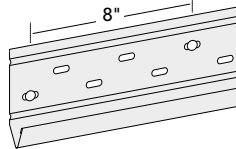

ACCESSORIES INSTALLATION: OUTSIDE AND INSIDE CORNER POSTS

- Position the top of vinyl corner post 1/4" from eave or soffit.

IMPORTANT: Hang corner post by placing first fasteners in the uppermost part of top slots at both sides of corner. **DO NOT** fasten through nailing flanges or any other accessories.

- Place all other fasteners in the center of nail slots, every 8" to 12".
- **Do not fasten tightly; corner post should be able to move to allow for expansion. Allow 1/32" clearance between fastener head and nailing hem for expansion.**

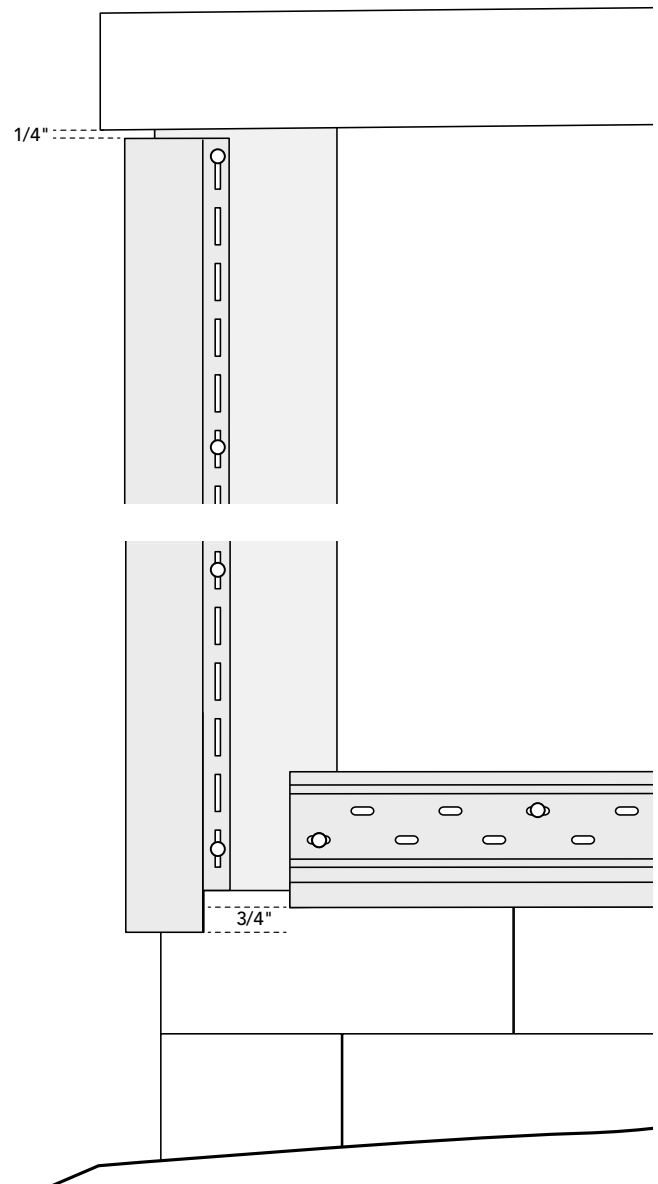

ACCESSORIES INSTALLATION: OVERLAPPING CORNER POSTS

- At the top of lower cornerpost, cut 1" off the nailing flanges and channels so just the face of the outside corner post remains. Then lap 5/8" of the upper post over the lower post, allowing 3/8" for expansion.
- When the bottom edge of a corner post terminates into a porch, deck, brick, stone ledge or roof line, etc., allow 3/8" for every 10' of corner when the ambient temperature is above 40°F; 1/2" for every 10' of corner when the ambient temperature is 40°F or below.

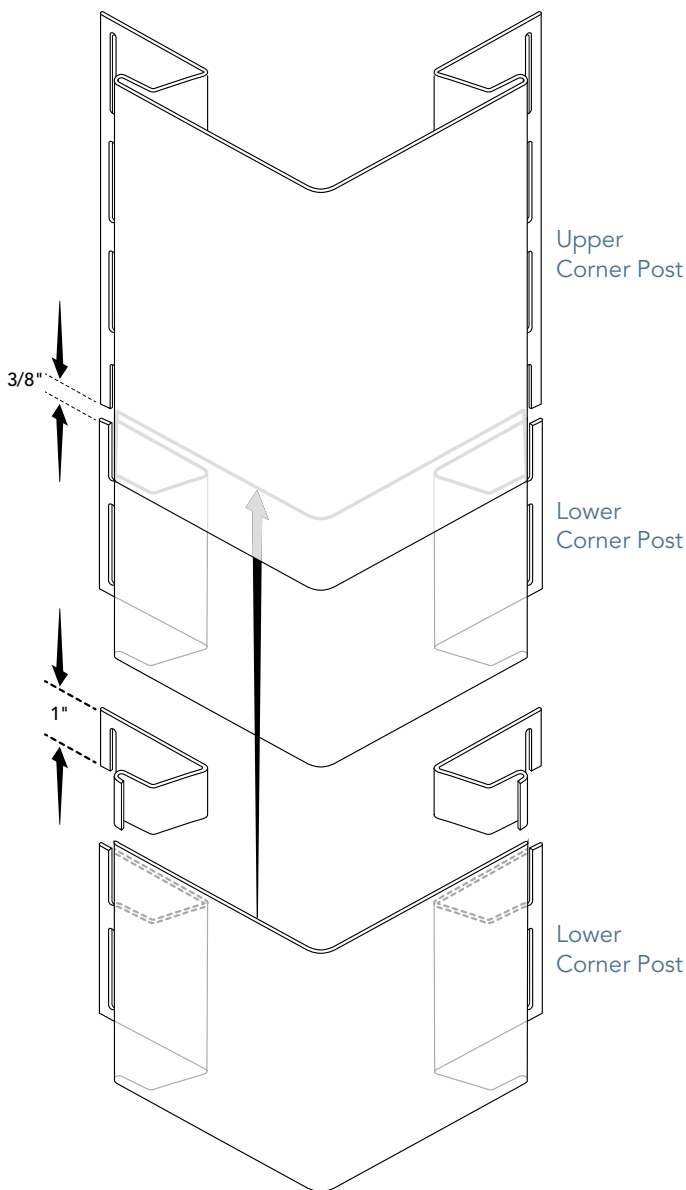

ACCESSORIES INSTALLATION: J-CHANNELS

BOTTOM RECEIVER

- Make sure channels are level by snapping a chalk line.
- Drill minimum 3/16" diameter weep holes every 24". Leave a gap between the J-channel and the head flashing. J-channel should not rest on head flashing because it will block weep holes and will prevent adequate drainage.
- When joining two J-channels, cut one of the J-channel's nail flange and U shape hook leg at the face of the J-channel and insert into the adjoining J-channel 3/4" to create a clean overlap, leaving a 1/4" gap between hook legs.

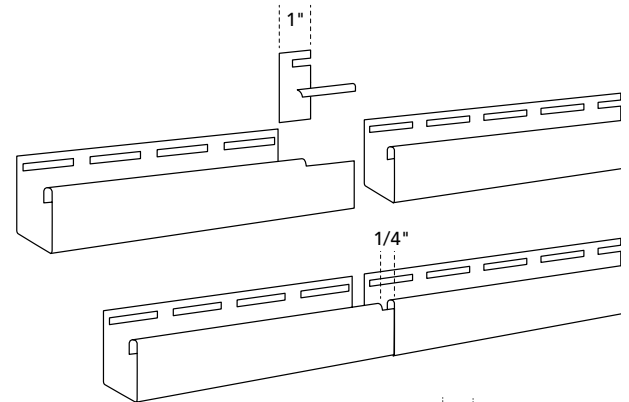

WINDOWS/DOORS/OBSTACLES

- Before installing J-channel, make sure the substrate meets requirements for a weather-resistant barrier system, including a weather-resistant barrier and proper flashing around windows, doors, other openings, and corners.
- Begin cutting J-channel at the bottom of obstacle; measure width of the frame plus width of J-channel face to be installed at the jambs.
- Cut J-channels at the jambs; measure height of frame plus width of J-channel at the top and bottom of frame.
- Cut top J-channel; measure width of the frame plus width of J-channel face installed at the jambs. NOTE: J-channel will require weep holes as mentioned above.
- Create mitre cuts and tabs at the bottom of jamb pieces and both sides of top J-channel.
- Refer to fastener requirements, specs, and procedure above.

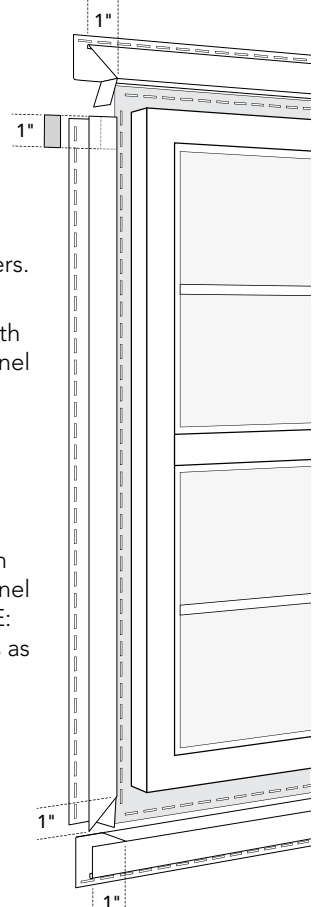

Continued on page 8

ASCEND 7" PLANK INSTALLATION INSTRUCTIONS

ACCESSORIES INSTALLATION: J-CHANNELS Continued

ROOFLINES AND GABLES

- Maintain a minimum of 1/2" from roofline shingles and step flashing.
- When joining two J-channels, cut one of the J-channel nail flange and U shape hook leg at the face of J-channel and insert into the adjoining J-channel 3/4" to create a clean overlap.

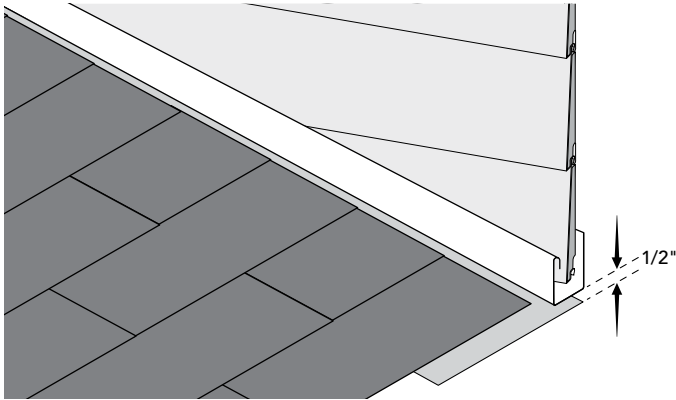

CUTTING CLADDING INSTRUCTIONS

- For vertical cuts to planks starting and finishing a course, transitioning into receiving channels, and overlaps, use the following tools:
 - Circular saw with a diamond blade or fine tooth (plywood) blade installed backward.
 - Tin snips; avoid closing blade completely at end of each stroke for a cleaner cut.

IMPORTANT: Vertical cuts must be straight; use a straight edge or carpenters square.

- For horizontal cuts above and below obstacles and finishing top course under overhangs, use the following tools:
 - Angle grinder with diamond blade.
 - Utility knife or scoring tool; score across and through the face of plank, into foam backing, and snap in half.
- For angle cuts in rakes and gables, saws, snips and angle grinders are acceptable.

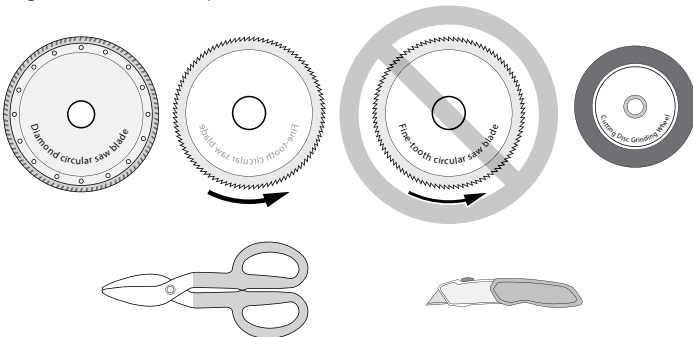

CLADDING INSTALLATION: 7" PLANK

- First course (row of planks) should be seated down into the starter strip. Planks should fully engage into the starter strip, but do not force down or create compression when fastening planks. **Plank should lay flat against wall.**
- **Allow for expansion and contraction by leaving 3/8" clearance between cladding and all corner posts and horizontal or vertical channels.**
- Remove plank factory notch before inserting into all receiving channels at corners, windows, doors and other obstacles.
- Avoid using planks shorter than 24" to start and finish a course.
- Check every 5th course for horizontal alignment on same and adjoining walls.
- When planning course layout, the first overlap should not occur in planks immediately above or below windows, doors, and other obstacles. For subsequent overlaps occurring above or below windows, doors, and other obstacles, and not using finish trim or starter strip, shim behind overlaps for proper plank projection and secure fit in J-channel.
- Refer to fastener requirements and specs above.

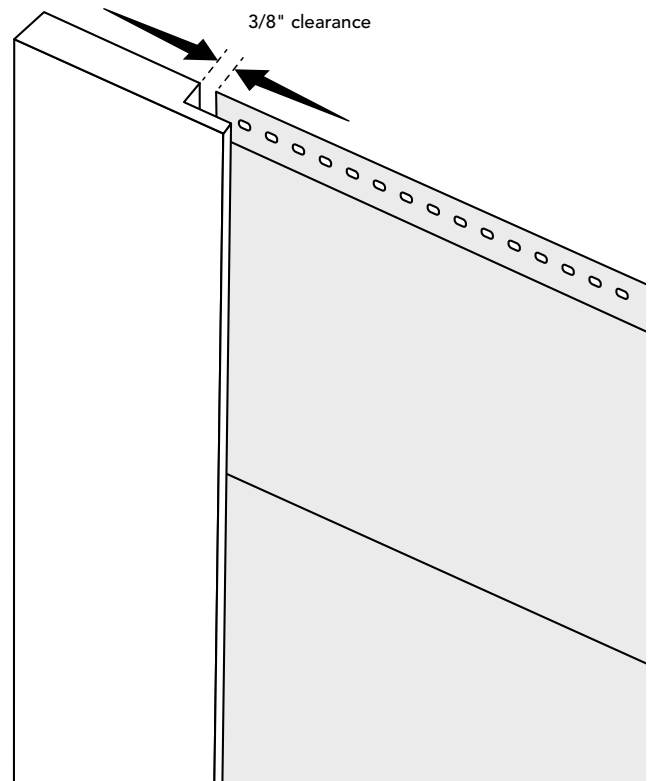

FASTENING PROCEDURE: CLADDING

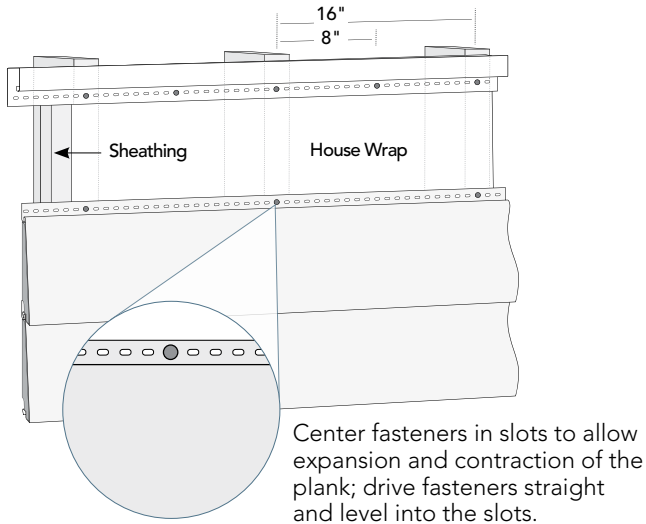

- If a nail slot does not allow centering/securing into nailable structural member, use a nail hole slot punch to extend the nail slot and allow centering of fastener.
- When using power nail guns and staplers, set and adjust air pressure ensuring 1/32" clearance between each fastener and nailing hem.

For information on fastening ASCEND and wind speed resistance, refer to Intertek CCRR-0316 and ICC ESR-4449 reports.

OVERLAPPING PLANKS

- Overlap away from areas with high traffic.
- Stagger cladding overlaps so that no two courses are aligned vertically unless separated by at least three courses.

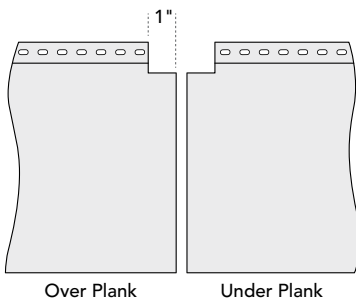

- Install fastener on lower course in nail slot closest to plank overlap.

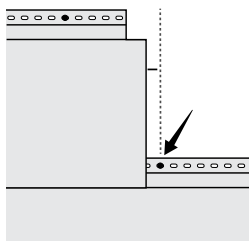

IMPORTANT: For applications using "soft" walls instead of a nailable substrate like OSB, the fastener at the lap must be a #8 truss or pan head screw and penetrate through the "soft" wall sheathing.

IMPORTANT: FIELD CUT REQUIRED

- A straight end cut required on Under Plank for proper overlap.

SAW CUT:

- Flush cut through entire Under Plank. **NOTE:** Cut should be flush through the nail hem to the bottom of the plank.

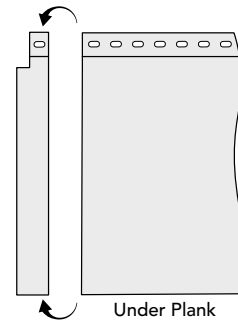

LAP METHOD – PREFERRED:

- Install Over Plank factory edge as the first plank of each course.
- Install subsequent Under Planks by sliding the Under Plank factory edge behind the Over Plank factory edge. **Maintain 1/2" overlap from cut of Under Plank. Do not butt foam to foam.** Maintaining a 1/2" overlap gap will give you approximately a 1/2" foam gap between planks.

LAP METHOD – TRADITIONAL:

- Overlap by sliding the Over Plank toward the Under Plank.
- Slightly lift the Under Plank while sliding the Over Plank 1/2" in front of the Under Plank so that the Over Plank seats down in the course below it first, then seat overlap down into the lock. **Maintain 1/2" overlap from cut of Under Plank. Do not butt foam to foam.** Maintaining a 1/2" overlap gap will give you approximately a 1/2" foam gap between planks.

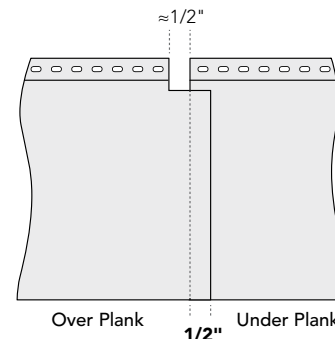

Stacking down Over Plank or failure to slightly lift Under Plank when overlapping, resulting in stress or flex of factory edge will void warranty

ASCEND 7" PLANK INSTALLATION INSTRUCTIONS (CONT'D)

INSTALLATION AROUND OBSTACLES:

- Use mounting blocks with a receiving channel ring when installing cladding around fixtures such as faucets, vents, lights, pipes, lines, etc. **Allow clearance (3/8") in receiving channels (horizontal and vertical) when installing cladding.**
- Install ASCEND finish trim for maintaining plank projection and securing cladding on horizontal surfaces under and above windows, doors, and other obstacles when the width is greater than 1 ft. **DO NOT install finish trim vertically with the 7" plank.**
 - ASCEND finish trim is used anytime the top nail hem or bottom stack lock of plank has been removed (see exception below). ASCEND finish trim is inserted into the sill and header receiving channel. Receiving channel is installed prior to finish trim and measurements for plank cuts.

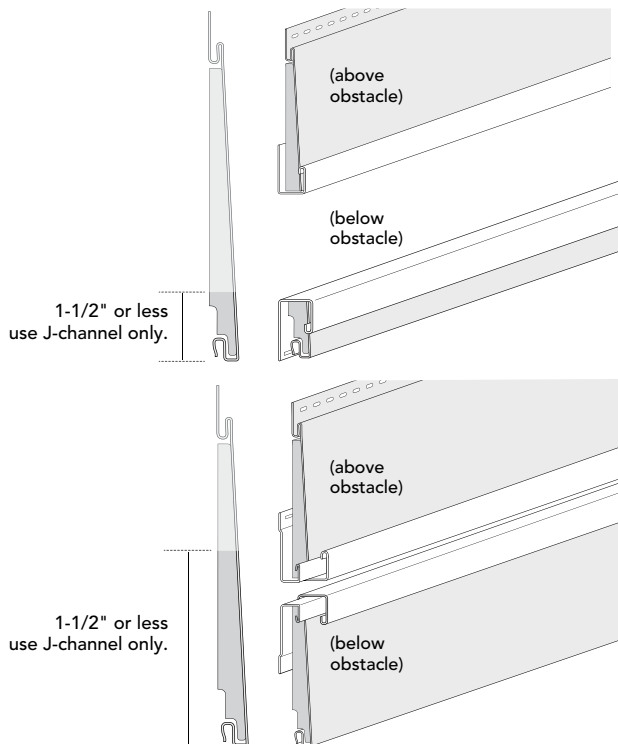

- When measuring the plank horizontal cut under obstacles, place tape measure into the backside of the receiving channel and measure to the top of the plank face of previously installed plank (past nail hem). Transfer measurement plus 1/4" to the cladding plank by pulling tape measure from the bottom of plank and mark measurement plus 1/4". Remove top of plank to the width of obstacle plus clearance (1/4" or 3/8") on both sides of obstacle.

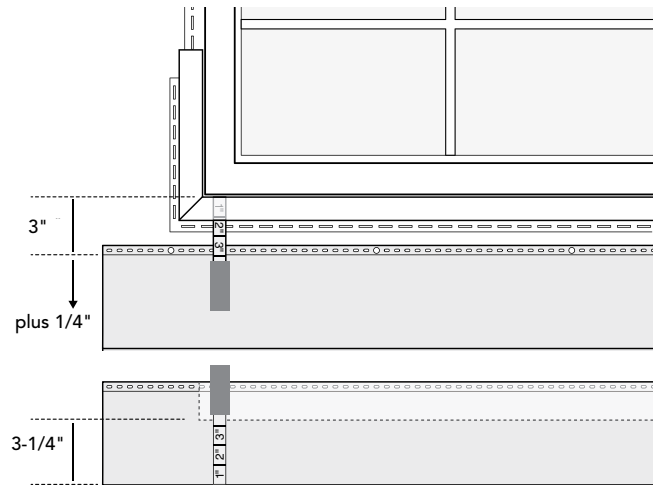

- When measuring the plank horizontal cut above obstacles, hook tape measure onto the backside of the receiving channel and measure to the top of the plank face of previously installed plank (past nail hem). Transfer measurement plus 3/4" to the cladding plank by pulling tape measure from the bottom of plank and mark measurement plus 3/4". Remove bottom of plank to the width of obstacle plus clearance (3/8") on both sides of obstacle.

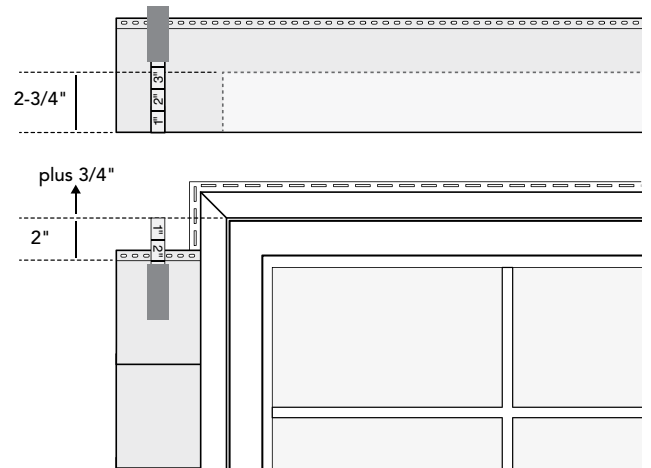

- Cut plank using a utility knife or angle grinder. Ensure proper safety equipment.

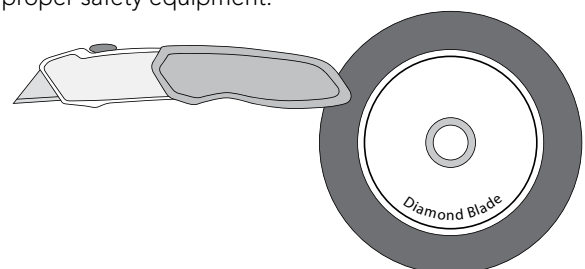

NOTE: Horizontal cuts occurring 1-1/2" or less from bottom butt of cladding do not require finish trim. Place up to 1-1/2" of cladding at the bottom butt into receiving channel only.

Finish Trim Usage Exception – Below Obstacle Rip Cut

- When horizontal cut occurs in the light shaded zone, finish trim is required.
- When horizontal cut occurs in the dark shaded zone, insert cut plank into receiving channel only, no finish trim required.

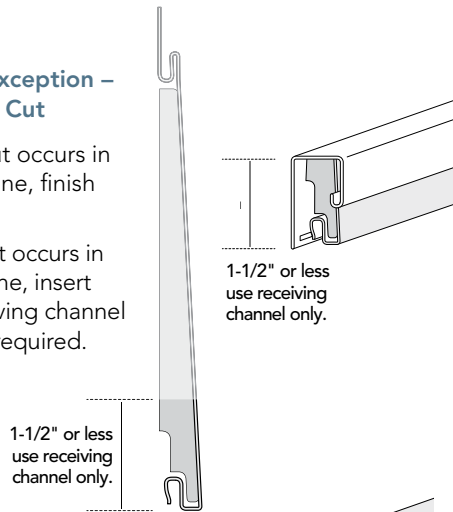

Finish Trim Usage Exception – Above Obstacle Rip Cut

- Drill 3/16" weep holes in finish trim.
- Install finish trim into the receiving channel header and sill of windows, doors, and other obstacles after taking measurements for plank horizontal cuts. **Finish trim should be installed flat against the wall.**
- ASCEND finish trim will allow plank to maintain projection while securing the horizontal cut section of the plank.

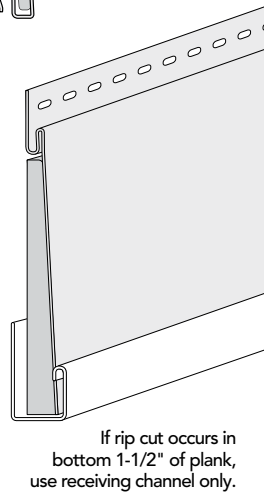

FINISHING TOP OF WALLS

LAST COURSE INSTALLED HORIZONTALLY IN RECEIVING CHANNEL AT THE EAVES

- Install receiving channel under the soffit or eave to receive ASCEND finish trim.
- Place tape measure into the backside of the receiving channel and measure to the top of previously installed plank (past nail hem). Transfer measurement plus 1/4" to the cladding plank by pulling the tape measure from the bottom of plank and mark the measurement plus 1/4", remove top of plank.

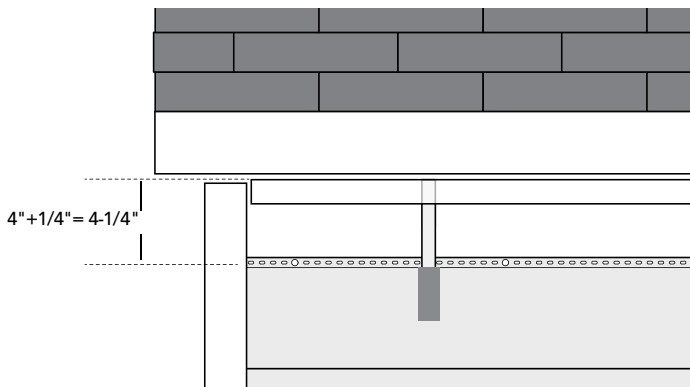

- Cut plank using a utility knife or grinder blade.

NOTE: Horizontal cuts removing top of cladding plank and leaving 1-1/2" or less of cladding plank at the bottom butt do not require finish trim. Place up to 1-1/2" of cladding at the bottom butt into receiving channel only.

- Install finish trim into the receiving channel or other channeled accessory previously installed under the soffit. Finish trim should be installed flat against the wall.
- Push ASCEND plank completely into the finish trim before engaging the plank stack lock into previous course.
- ASCEND finish trim will allow plank to maintain projection while securing the horizontal cut section of the plank.

GABLE INSTALLATION

- Make a pattern that duplicates the angle or slope of the gable by stack-locking a small piece into the last course of cladding installed before the gable starts.
- Place a second piece into the gable receiving channel and mark slope on the small piece of cladding.
- Remove small piece and cut along mark for a pattern to make gable cuts. Ensure accuracy of angle to preserve required clearance into channel.
- **Ensure 3/8" clearance in receiving channel for plank expansion.**
- Repeat steps at the opposite side of the gable.
- Last piece installed at the top of the gable will be installed with a trim nail. Pre-drill a hole the diameter of trim nail shank prior to fastening plank with a trim nail.

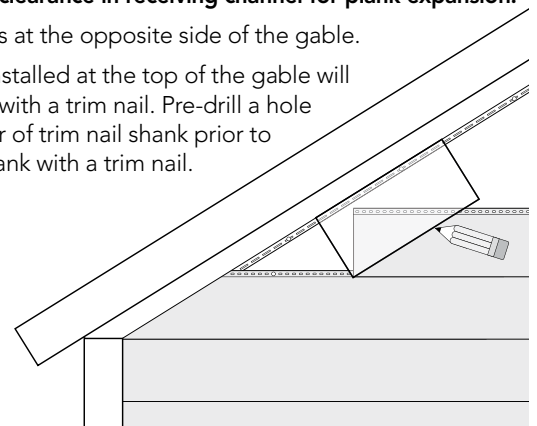

MASONRY TO ASCEND TRANSITION

- Caulk where substrate meets the top of flashing, and between the masonry and bottom of head flashing.
- Apply field-formed head flashing and tape.
- Install receiving channel or starter strip for horizontal ASCEND cladding.
- There must be a gap left between the starter strip and the flashing. If the starter strip is touching the flashing, the ASCEND plank will not engage properly.

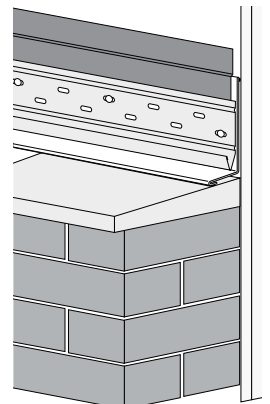

ASCEND 12" BOARD & BATTEN INSTALLATION INSTRUCTIONS

CLADDING INSTALLATION: BOARD & BATTEN

BOARD & BATTEN LAYOUT

- Before cutting and fastening the first Board & Batten panel, plan the wall layout to have a balanced appearance with a Batten centered in the peak if installing in a gable. A balanced appearance will have an equal number of full panels to the right and left of the center point of a wall and end pieces will be the same width.

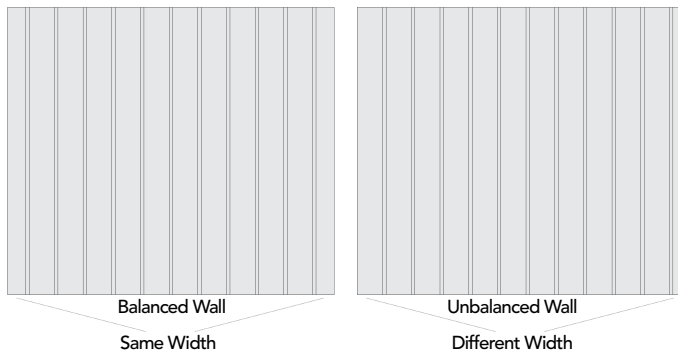

CALCULATING A BALANCED WALL APPEARANCE

To create a balanced wall appearance, you will need to know the following:

- Total width of wall (inches) from outside edge of receiving channel to outside edge of receiving channel, less required clearance for expansion, 1/4" clearance in each receiving channel). (A)
- Divide the result of (A) by 12" exposure of full Board & Batten panel, this will result in the number of full-length panels and remaining inches for partial panels. (B)
- Using remaining inches from (B) and divide by 2 for the rip cut width of Board & Batten end pieces. (C)
- The starter rip cut panel should be 1" shorter than half the remaining inch total. The terminating rip cut should be 1" longer than half the remaining inch total.

WALL EXAMPLE

1. Width of receiving channel – 272"
 - $272" - 1/4" - 1/4" = 271-1/2"$ (A)
 - The 1/2" is 1/4" doubled for clearance into receiving channel
2. Divide 271-1/2" (A) by 12 for full length panels. This comes out to 22 full panels.
 - $271-1/2" - 264" (22 \text{ full panels}) = 7-1/2"$ (B)

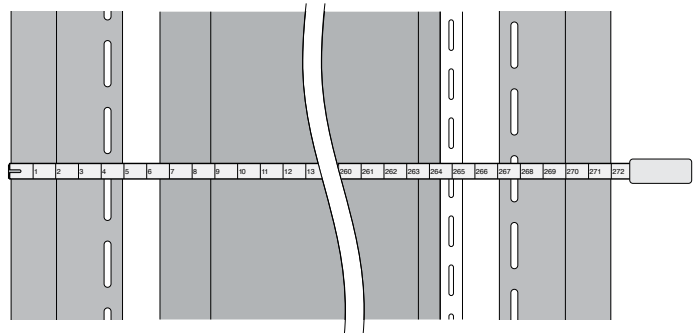

3. Divide 7-1/2" (B) by 2 to get 3-3/4" (C)
 - For the starter rip cut panel (piece with the nail hem slots), subtract 1" from 3-3/4" (C) to make your rip cut = 2-3/4" as measured from the lock.

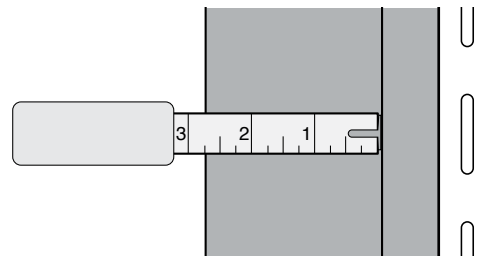

- For the termination rip cut panel (panel with the batten strip), add 1" to 3-3/4" (C) to make your rip cut = 4-3/4" as measured from the batten.

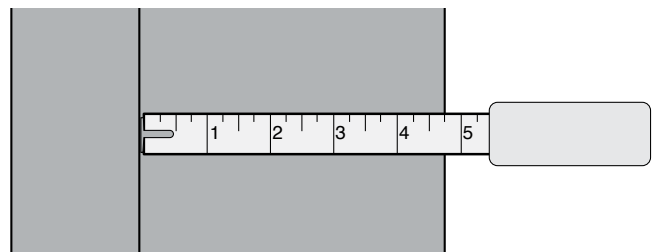

CALCULATING A BALANCED GABLE APPEARANCE

To create a balanced gable appearance with the batten strip centered at mid-point of gable, follow the steps below:

- Drop a plumb line from the center of gable and then strike a vertical chalk line 1" left of mid-point line. At base of gable, measure from the chalk line to inside of receiving channel at end of gable. (A)

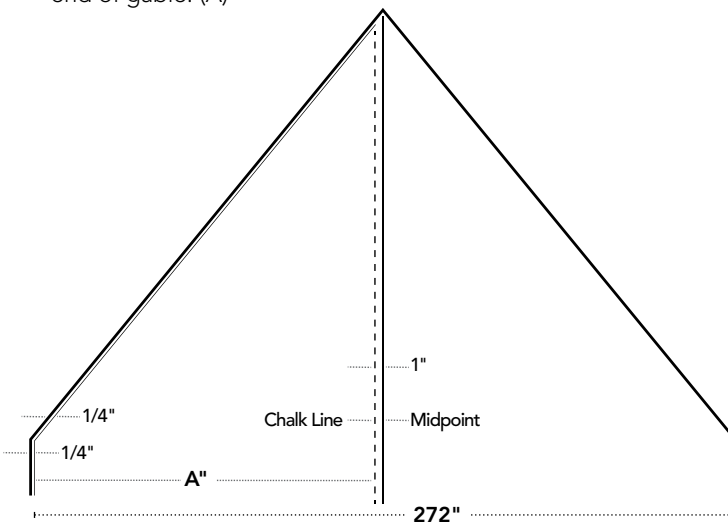

- Divide by 12" to determine number of full panels (B) and one partial panel that will serve as the starter piece for the left side of the gable.
- For the starter piece width, multiply 12" by the number of full panels (B) and subtract that value (C) from the base of gable measurement (A). Deduct a 1/4" clearance from partial piece width (D) for clearance in channeled accessory (E). Measure (E) from inside part of nail hem as shown below and cut panel.

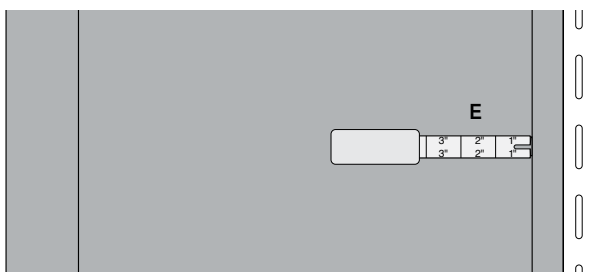

Note: If wall installation transitions into a gable, reference gable installation instruction to make sure wall installation remains centered. Follow same instruction.

GABLE EXAMPLE

1. Drop a plumb line from the center of the gable. Mark your vertical chalk line 1" to the left of the line. Measure from the inside of the receiving channel to the chalk line.
 - $136" - 1" = 135" (A)$
2. Divide 135" (A) by 12 for full length panels.
 - $135" (A) \div 12" = 11 \text{ (full panels) (B)}$
3. Multiple 11 (B) by 12" for total width of full length panels.
 - $12" \times 11 \text{ (full panels) (B)} = 132" (C)$
4. Subtract 132" (C) from 135" (A) to get partial piece width.
 - $135" (A) - 132" (C) = 3" (D)$
5. Subtract 1/4" from 3" (D) to ensure clearance in channeled accessory.
 - $3" (D) - 1/4" = 2-3/4" (E)$

CUTTING BOARD & BATTEN PANELS

For vertical, angular or horizontal rip cuts at corners, windows, doors and other obstacles use the following tools:

- Circular saw with a diamond blade or fine tooth (plywood) blade installed backwards.
- Angle grinder with diamond blade.
- Tin snips; avoid closing the blade completely at the end of each stroke for a cleaner cut. Also maintain a straight cut when cutting through the width of the panel.
- Utility knife or scoring tool; score across and through the face of panel, into foam backing, and snap in half.

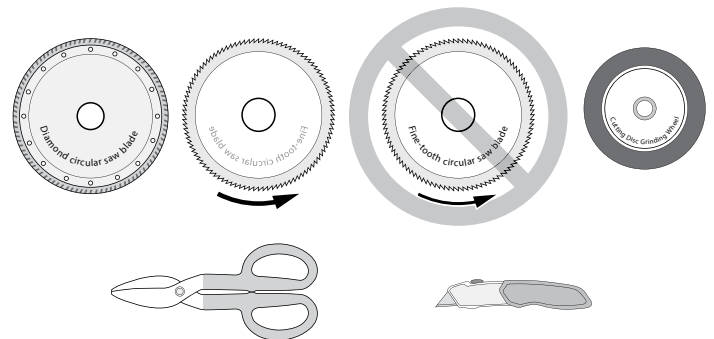

ASCEND 12" BOARD & BATTEN INSTALLATION INSTRUCTIONS (CONT'D)

BOARD & BATTEN ACCESSORIES INSTALLATION

- Use 3/4" x 3/4" receiving channel accessories such as J-channel, at bottom and top of wall, transitions, corners, windows, doors and other obstacles.

Note: Ensure a 1/4" clearance between Board & Batten panel and top accessory channel.

- Channel accessories are used to frame the bottom of Board & Batten panels at the top and bottom of a wall.

Note: Ensure a 1/2" clearance between Board & Batten panel and bottom channel.

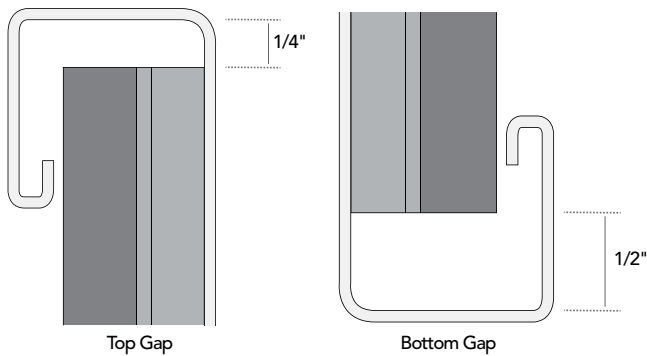

IMPORTANT: For water management, drill minimum 3/16" diameter weep holes every 12" to 24". Leave a gap between the J-channel and the head flashing. J-channel should not rest on head flashing because it will block weep holes and will prevent adequate drainage.

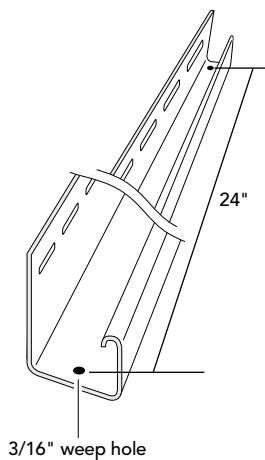

- Channeled accessories are used to frame the top and bottom of Board & Batten panels, as well as gable and rake accent applications.

BOARD & BATTEN INSTALLATION: WALL AND GABLE

- Reference "Fastener Requirements" section on page 5.
- When rip cuts or the "board" part of the panel is to be received into an accessory channel over 12", ASCEND finish trim is required and will secure the panel to the wall. Insert and fasten ASCEND finish trim into receiving channel before installing ASCEND Board & Batten panel.
 - Finish trim is not required in horizontal receiving channels or if "batten" part of panel is inserted into receiving channel.
 - Maintain a 1/4" horizontal clearance into finish trim, as shown below.

BOARD SECTION – Use Finish Trim

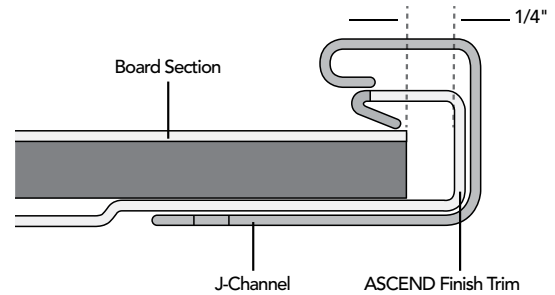

BATTEN SECTION – DO NOT Use Finish Trim

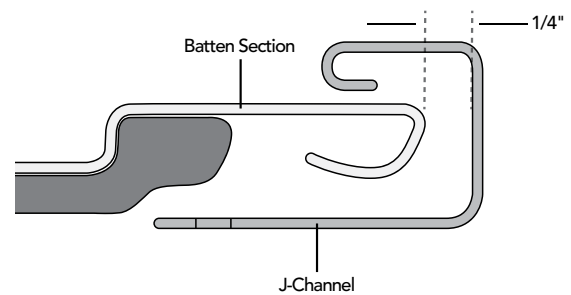

Note: Finish trim nail into board portion to keep rip cut panel in place at the top of the panel. Drill 1/8" diameter hole into board section of panel covered by receiving channel. Using a trim nail punch, fasten trim nail, DO NOT hard nail.

Note: Ensure a 1/4" clearance between Board & Batten panel and top accessory channel.

Note: Ensure a 1/2" clearance between Board & Batten panel and bottom channel.

- For smoother installation, cam/angle the batten when interlocking a new panel with the previous panel. Begin locking a few inches below the top accessory, then slide the panel upwards as it securely locks from the top down.
 - When making rip cuts around windows, doors, other obstacles, follow same finish trim use and clearance instructions as performed on rip cut of the first panel when span is greater than 12".
 - For best appearance, cover the clear flex leg of the finish trim, use the following techniques:
 - Using the rip cut panel, cut a piece of the batten strip and insert into flex leg pocket.
- OR**
- Install utility trim by removing the nail hem and inserting into flex leg pocket.

USE BATTEN STRIP

- Measure 1/2" and cut batten strip from panel as follows:

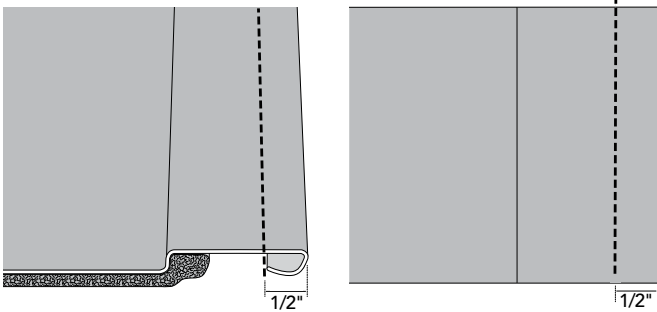

- Insert the batten strip over the finish trim.

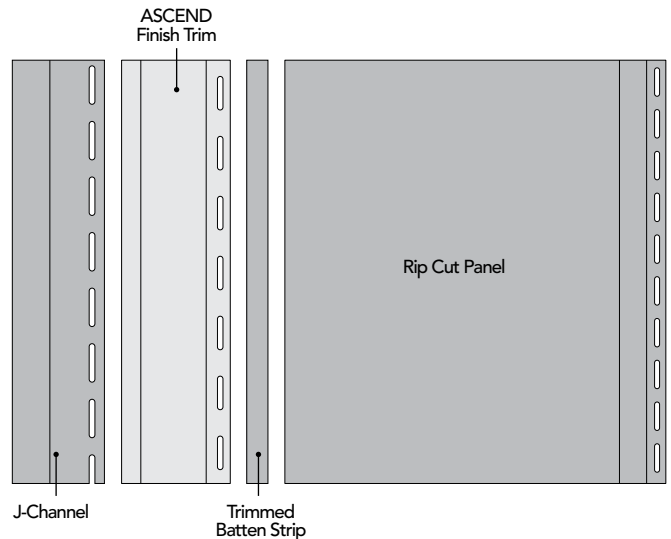
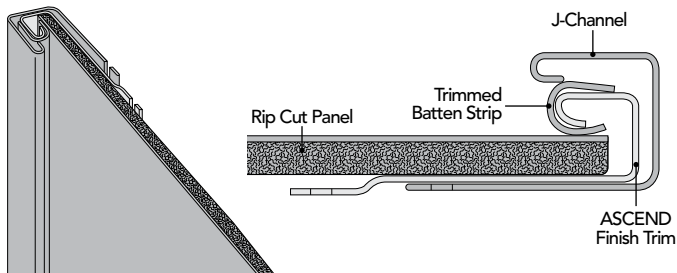

TIP: While this is a press/friction fit, it's optional to enhance its integrity by applying beads of caulk into the trimmed batten portion.

TRANSITIONS

Note: Board & Batten panels cannot be vertically overlapped.

- When a wall height extends beyond the length of one Board & Batten course or there is a transition to or from another material or cladding, make sure to include proper flashing when using J-channel and other receiving channel trims.
- ASCEND composite cladding H-Trim is designed with weep holes and tapered graphite polystyrene foam designed for water drainage.

ASCEND H-TRIM INSTALLATION INSTRUCTIONS

H-TRIM INSTALLATION: HORIZONTAL

- Channeled accessories are required when transitioning between a horizontal cladding to a board & batten or shake cladding. H-Trim is an option to meet this need. Position the H-Trim in the location where the transition will occur.

Note: Nail flanges should lay flush to the sheathing. DO NOT push down on H-Trim.

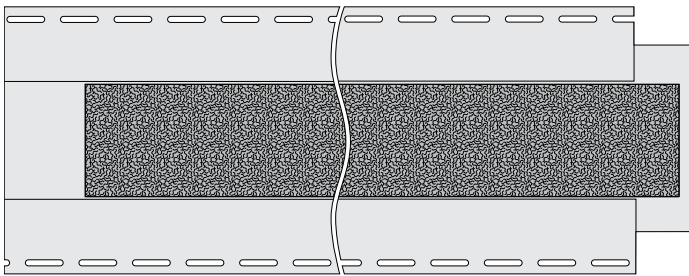

Note: One end of the H-Trim panel has recessed foam to enable another piece of H-Trim to create overlap.

STARTING A TRANSITION

- Cut through the entire piece just inside the edge of the foam to create a flush end cut.

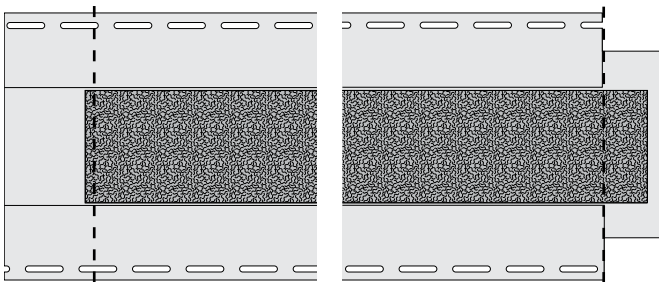

- Butt a flush cut end against the outer edge of the vertical accessory. DO NOT overlap the H-Trim nail flange on top of another product nail flange.
- If H-Trim nail flange overlaps the nail flange of a corresponding accessory, cut the nail flange back a minimum of 1/4" length past the vertical accessory nail flange.



- When used with a corner post or terminating into another vertical accessory, H-Trim is required to be restricted at that end. Place fasteners at the edges of the slot closest to end of panel to restrict movement in opposite direction on both the top and bottom nail flanges. This will restrict movement of H-Trim into the corresponding accessory. DO NOT fasten through nailing flanges of any other accessories.

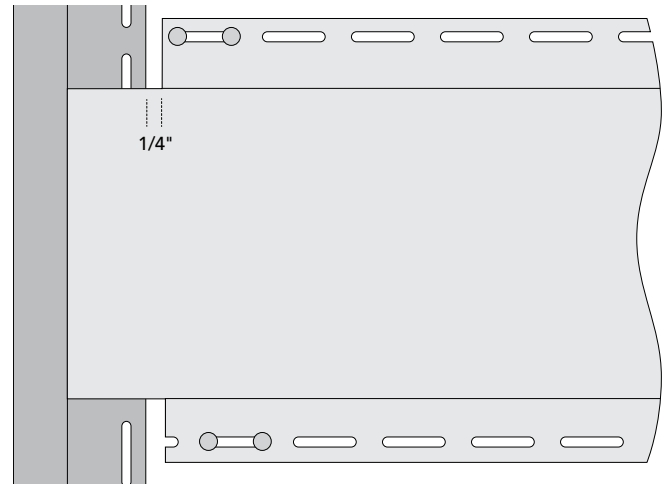

H-TRIM OVERLAP

- ASCEND composite H-Trim is designed with recessed foam on the trailing edge to accept the cutout/lap portion of a corresponding H-Trim piece. When lapping, H-Trim must go into a pre-existing end with recessed foam.

Note: Either the under panel or over panel may be installed first.

- Do not cut foam back on an already cut piece, use a new piece of H-Trim with recessed foam on all overlaps.
- Ensure 1-1/2" between the nail hems of the two H-Trim pieces. This will provide a 1" overlap between panels.

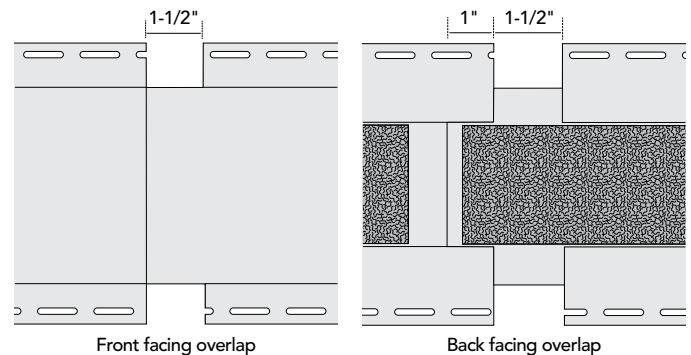

H-TRIM FASTENING

- Place fasteners 4-6 slots away from the lap on both panels.
- Nail flanges should lay flush to the sheathing. DO NOT push down on H-Trim.

Note: Installers should never cut the foam back or modify the foam setback on any of these transitions when the span of the transition is greater than a single piece of H-Trim.

- When installation of H-Trim spans more than two full length pieces, the middle H-Trim piece(s) is required to be center-pinned to restrict movement. Center-pinning is required on both the top and bottom nail hems at the center of each full length panel.

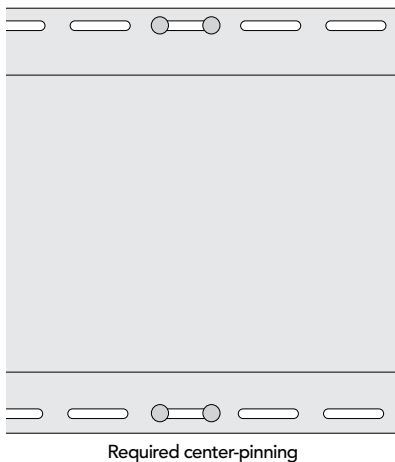

- Place fasteners every 16" on center on both the top nail hem and bottom nail hem.
- Ensure end of H-Trim course is not less than 18" in length.

H-TRIM INSTALLATION: VERTICAL

- H-Trim may be used in vertical applications when transitioning between two different plank profiles such as ASCEND 7" Horizontal and ASCEND 12" Board & Batten.
- The terminating points at both the top and bottom of the wall must be flush cut.
- Nail flanges of the H-Trim must not overlap the accessory it is butting up to. Follow instructions above on cutting procedures for these terminating points.

HANGING VERTICAL H-TRIM - FREESTANDING APPLICATION

- Position the top of H-Trim 1/4" from eave, soffit or channeled accessory.

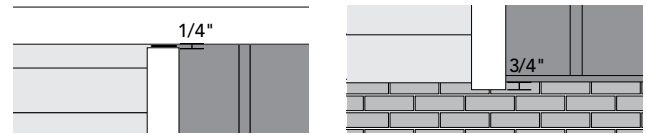

IMPORTANT: Hang H-Trim by placing first fasteners in the uppermost part of top slots at both sides. DO NOT fasten through nailing flanges or any other accessories.

- Place all other fasteners in the center of nail slots, every 8" to 12".
- DO NOT fasten tightly; H-Trim should be able to move to allow for expansion.
- Allow 1/32" clearance between fastener head and nailing hem for expansion.

HANGING VERTICAL H-TRIM - BUTTED APPLICATION

IMPORTANT: Position H-Trim by placing center-pinning in bottom most full slots on both sides. DO NOT fasten through nailing flanges or any other accessories. Cut the nail flange back a minimum of 1/4" length past the horizontal accessory nailing flange.

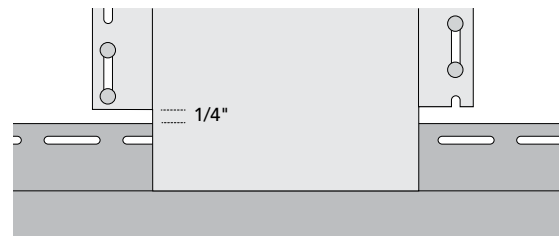

- Place all other fasteners in the center of nail slots, every 8" to 12".
- DO NOT fasten tightly; H-Trim should be able to move to allow for expansion.
- Allow 1/32" clearance between fastener head and nailing hem for expansion.
- Leave 3/8" clearance between H-Trim and top accessory.
- Overlap of the panel will have a 1-1/2" gap distance between nail hems. Center-pin higher panel in bottom most full slots on both sides.

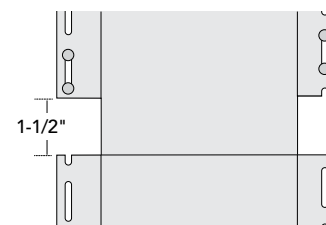

CELLULAR PVC TRIM INSTALLATION INSTRUCTIONS

CELLULAR PVC TRIM INSTALLATION: GENERAL INFORMATION

- Install trim over a continuous substrate.
- Fasteners shall penetrate substrate minimum 1-1/2".
- Leave the recommended expansion space between pieces of trim based on temperature at the time of installation.
- Use PVC cement or adhesives to join pieces of cellular trim.
- Use 100% acrylic latex house paint if paint color is an LRV (Light Reflectance Value) greater than or equal to 55%.
- If LRV is less than 55%, use a coating that is formulated specifically for exterior vinyl products.
- Use sealant to fill gaps, nail and screw holes.

TRANSPORTING AND STORING

- Trim is shipped to the jobsite in a plastic wrap to protect from dirt and debris.
- Store on a flat level surface.
- Handle trim with care to avoid damage.

CUTTING

- Use conventional wood working saws.
- Use carbide tipped blades designed to cut wood.
- Do not use fine tooth metal cutting blades.
- Do not reverse blades.

Avoid rough edges from cutting caused by excessive friction, poor board support, and worn saw blades.

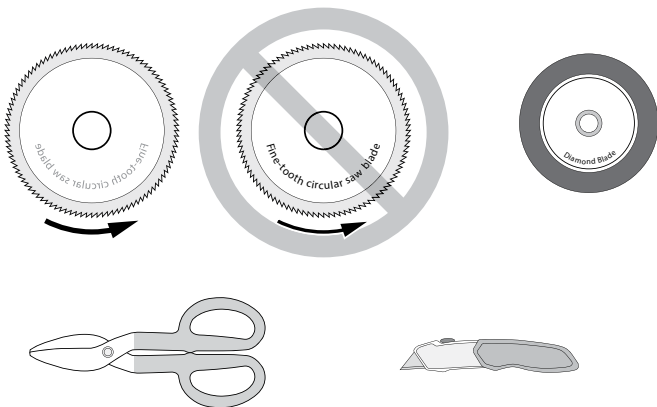

DRILLING

- Do not use bits made for rigid PVC.
- Avoid frictional build-up and remove shavings from the drill hole as frequently as necessary.
- Drill with standard wood-working drill bits.

MILLING

- Mill using standard milling machines used to rout lumber.
- Relief angle 20 to 30 degrees.
- Do not score material.
- Cutting speed to be optimized with the number of knives and feed rate.

ROUTING

- Rout using standard bits and the same tools used to rout lumber.
- Carbide-tipped router bits recommended.

EDGE FINISHING

- Edges can be finished by sanding, grinding, or filling with traditional woodworking tools.
- Sand with 150-220 grit sandpaper to create a smooth edge.

JOINTS

- Provide bevel or shiplapped joints for material subject to expansion and contraction. Do not use butt joints.
- Use butt joints for corner units or T-joints, only.

IMPORTANT: When field routing a solid board with a receiving channel, minimum 3/4" pocket depth and 3/4" projection routes are required.

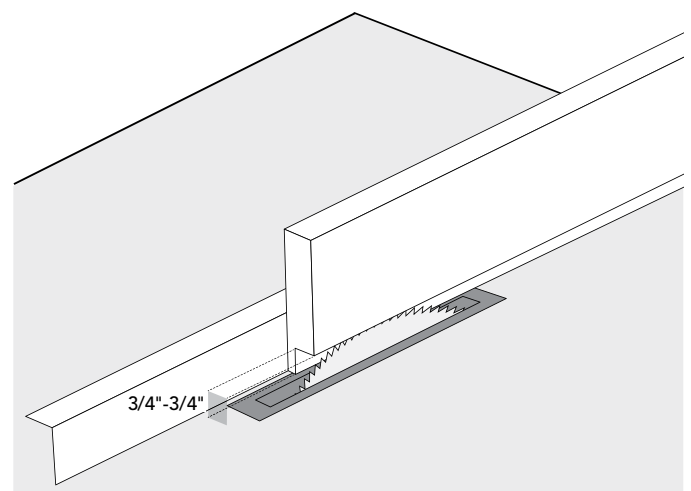

EXPANSION/CONTRACTION

- Under normal conditions and when installed properly, PVC trim will expand/contract approximately 1/8" per 18'.

IMPORTANT: Failure to use proper type and quantity of fasteners may result in expansion/contraction greater than 1/8". Provide bevel or shiplapped joints for material subject to expansion and contraction. Do not use butt joints.

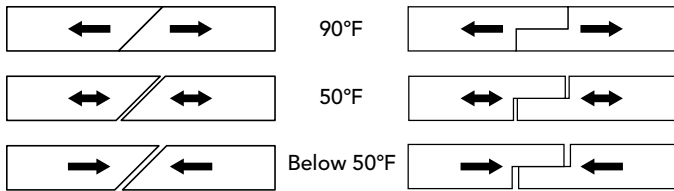

FASTENING

- Fasteners shall be hand nailed, power nailed, or screwed.
- Power nailing: adjust nail gun to prevent excessive nailing pressure or overdriving the nail. Adjust for ambient and material temperatures.
- Pre-drill material when installing in low temperatures.
- Fasteners should be long enough to penetrate into a 1-1/2" solid wood substrate a minimum of 1-1/2".
- Staples, small brads, and wire nails must not be used as fastening members.
- Fasten trim into a flat, solid wood substrate that is a minimum 1-1/2" thick. Do not fasten trim into hollow or uneven substrates.

FASTENER SCHEDULE

- Along length of board: fasten at 16" on center, maximum.
- Within width of board: 4" on center, maximum.
- Distance from end of each board: Not more than 2".

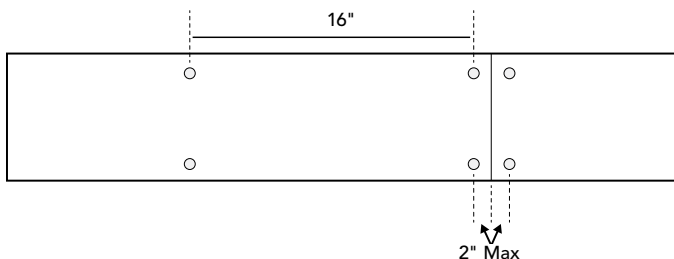

BONDING

- Follow adhesive manufacturer's guidelines.
- Glue joints shall be secured on each side of the joint to allow adequate bonding time.
- Surfaces to be glued should be clean and dry and in complete contact with each other. Smooth surfaces shall be sanded and cleaned prior to bonding.
- Use PVC adhesive when installing short runs of trim.

FINISHING

- Correct dents and gouges before applying final coating.
- Nail holes should be filled using Structural Sealant, Cellular PVC Adhesive or Nail Stick.
- Clean material with a light detergent and warm water. Stubborn stains may be removed with rubbing alcohol.

SKIRTBOARD INSTALLATION AT GRADE

- Skirtboard can be installed for aesthetics, but is not required for installation of ASCEND cladding at grade.
- Skirtboard design with a kick out leg at the top is not compatible with ASCEND.
- To achieve aesthetics of skirtboard, use solid trim board with field-formed head flashing and ASCEND starter strip above the trim board.
- ASCEND starter strip needs to be offset about 1/8" to 1/4" from top of skirtboard or flashing.

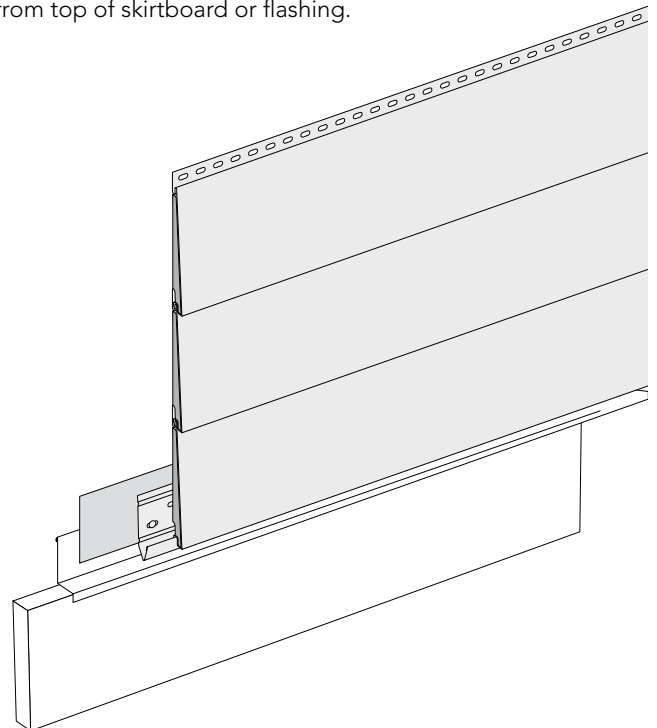

CELLULAR PVC TRIM INSTALLATION INSTRUCTIONS (CONT'D)

MASONRY TO CLADDING TRANSITION

- Water Table design with a kick out leg at the top is not compatible with ASCEND. Remove kick out leg, install head flashing with tape and ASCEND starter strip or receiving channel.
- **Option:** To achieve aesthetics of Water Table, use solid trim board with field-formed head flashing with tape and ASCEND starter strip or receiving channel above the trim board.

BAND BOARD INSTALLATION

- Band board aesthetics will require a field-routed pocket 3/4" x 3/4" at the bottom of a solid trim board.
- Install ASCEND finish trim into the field routed pocket (see Finish Trim Usage Exception Section on page 9).
- Finish last course of cladding into ASCEND finish trim.
- Head flashing should be formed and installed above band board.
- Install starter strip or channel to receive first course of cladding above band board.

INSIDE CORNER INSTALLATION

- Install 3-1/2" trim board with channel to receive cladding.
- On the adjacent wall from 3-1/2" trim board, remove 1" wide strip from trim board and install the backside against the 3-1/2" trim board.

ONE-PIECE OUTSIDE CORNER INSTALLATION

- 3-1/2" and 5-1/2" one-piece corner boards are recommended.
- Install two fasteners evenly spaced across each side, maximum 16" spacing across entire length of corner.

WINDOW SURROUND INSTALLATION

- Before installing trim, flash opening in accordance with AAMA method A1 or local building code requirements.
- For new construction, trim boards with channel and nail fin cutout are recommended.
- Cut sill, jambs and header to assemble picture frame of trim prior to installing on the wall.
- When making mitre cuts at corners, additional field cuts are not required.
- When making square cuts at corners and using the historic and solid sill, two field cuts are required to receive cladding:
 - Field route a 3/4" x 3/4" pocket at the bottom backside of sill. Cut ASCEND finish trim length 2" less than sill length and insert into the routed sill pocket.
 - Exception: when using cellular trim with a channel, field route at backside is not required.
 - Field route 3/4" x 3/4" pocket across installed height of sill ends and top of both jamb pieces, to provide a continuous receiving channel at corners to receive plank.
- Install screws through bottom of sill into the jamb trim boards.
- Glue and screw the header into the top of jambs.

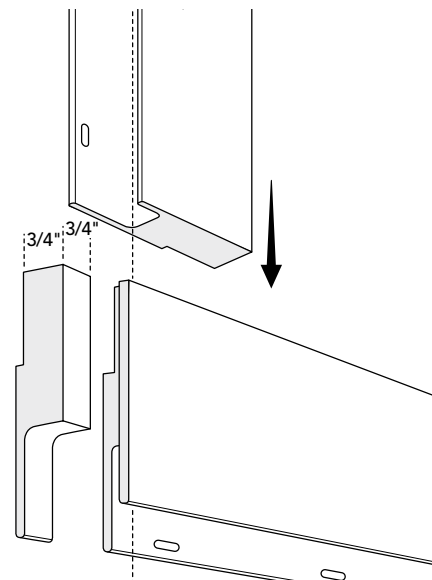

SPECIALTY RECOMMENDATIONS: SHUTTER INSTALLATION

- Pre-drill holes through shutter and mark location of these holes on the cladding.
- Drill a hole 1/4" larger than the diameter of shutter screw shank in plank.
- Do not fasten tight.

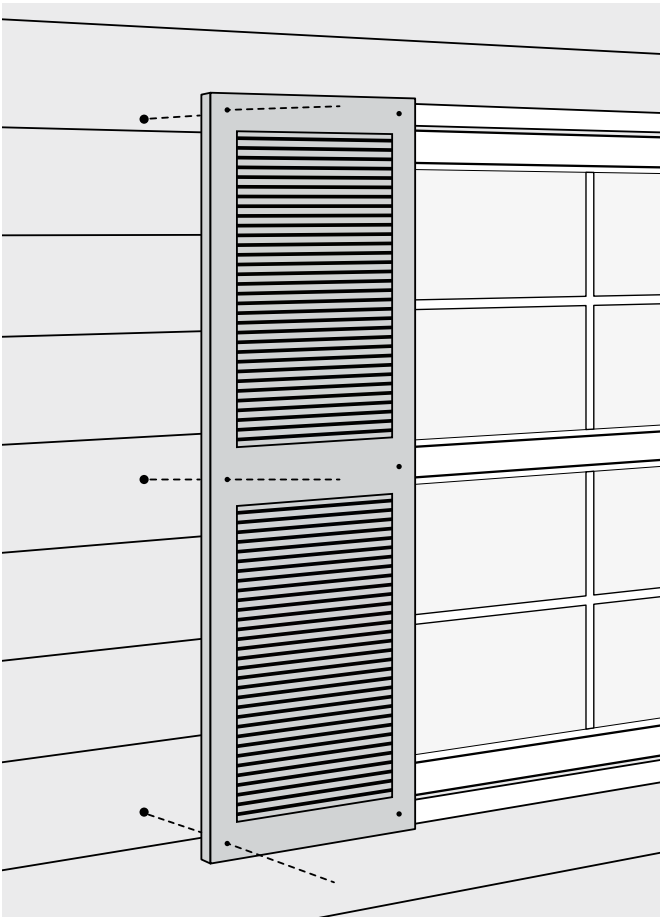

ATTACHMENT OF OTHER PRODUCTS

- Requires a hole to be 1/4" larger in diameter than fastener shank diameter used to attach product.

REPLACING A DAMAGED PLANK – ASCEND 7" PLANK

- 1 Locate an overlap of the cladding course above damaged plank.
- 2 Slide pry bar under the overlap of the cladding course above damaged plank.

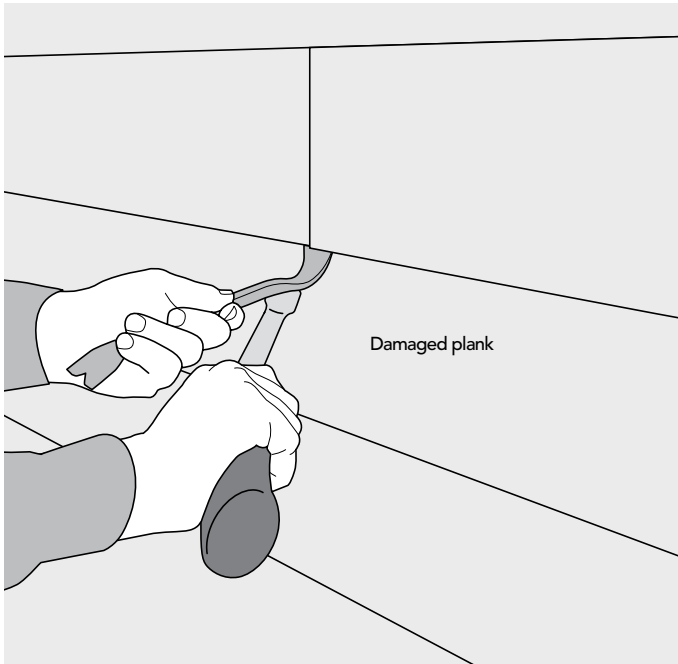

- 3 Using a hammer, tap up on the pry bar to unlock stack lock from the top lock of damaged plank. Repeat this step, working away from the overlap until stack lock is unlocked across the length of damaged plank.

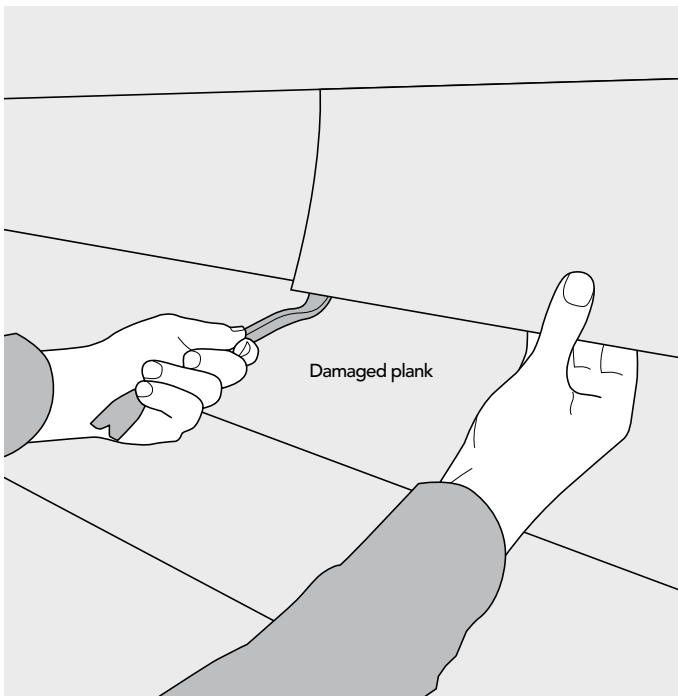

- 4 Place wood shims behind the cladding planks allowing more room to the nail hem of damaged plank.

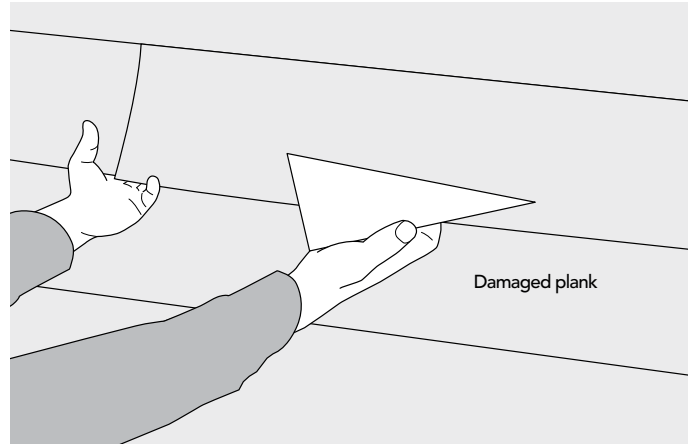

- 5 Remove fasteners from damaged plank.

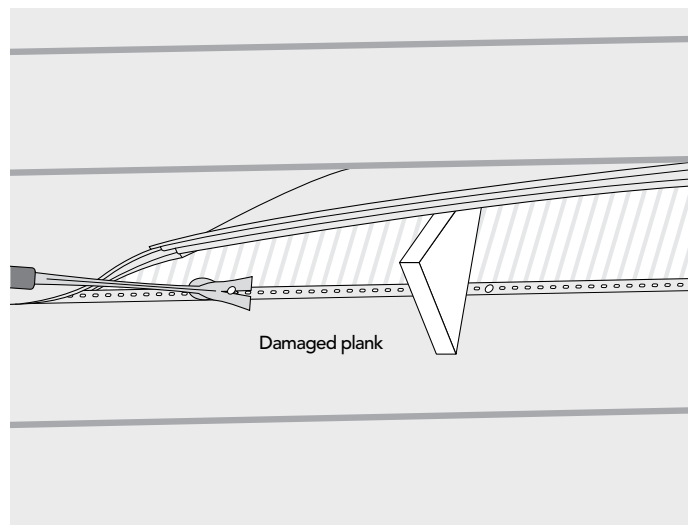

- 6 Unlock and remove damaged plank.

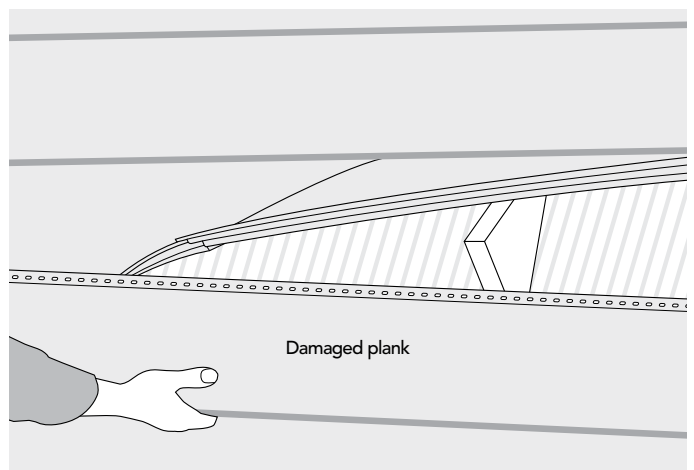

- 7 Install replacement plank and fasten. See "Fastening Procedure: Cladding" section on page 9.

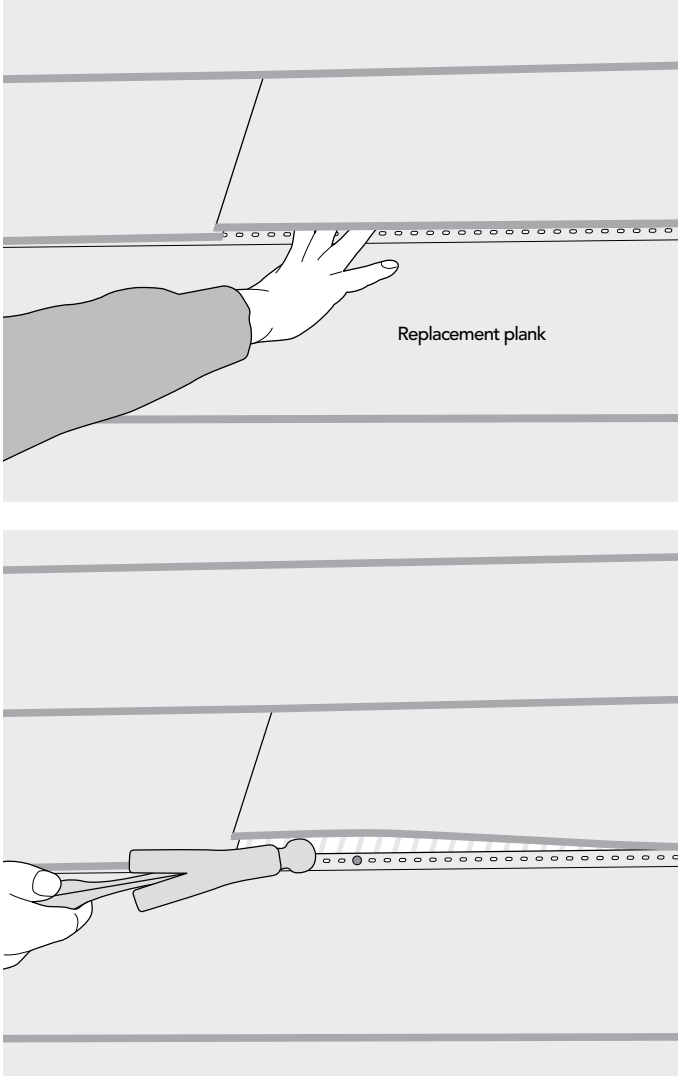

- 8 Remove shims and starting at overlap, apply upward pressure to the bottom lock leg to engage stack lock into top lock of replacement plank.

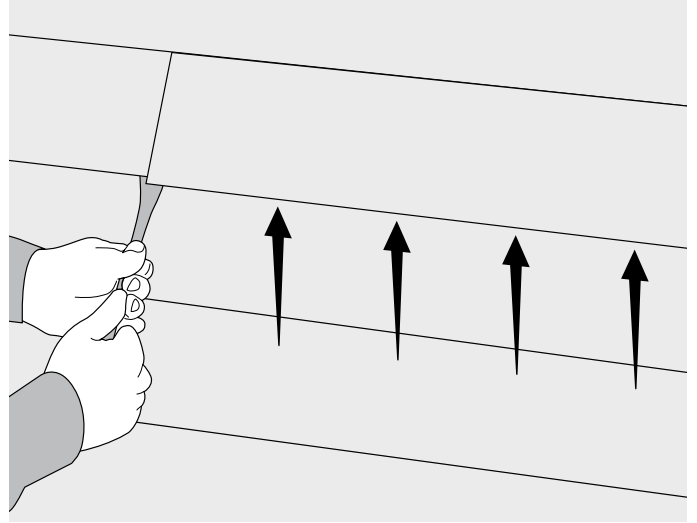

REPLACING A DAMAGED PANEL – ASCEND 12" BOARD & BATTEN

- 1 Slip the zip lock tool or unlocking tool behind the panel next to the one to be replaced and unzip it from the lock of the damaged panel. Repeat this step, until lock is unlocked across the full length of damaged panel. Gently bend out the panel.

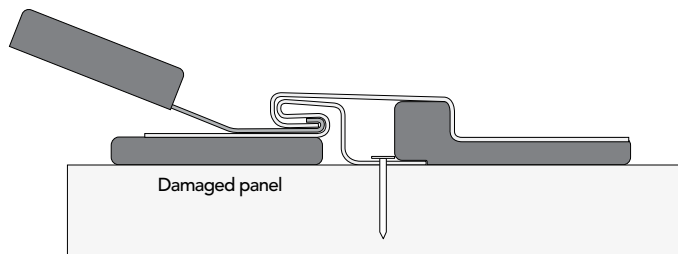
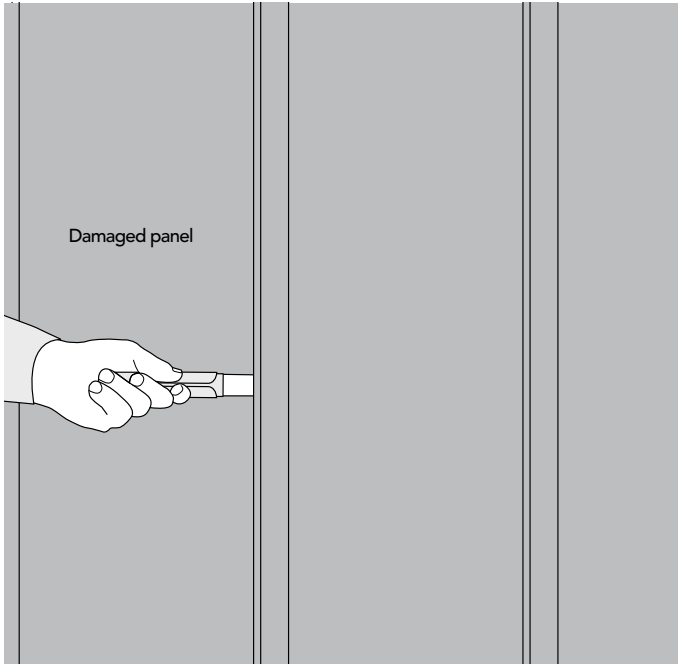

- 2 Place wood shims behind the cladding panels to allow more room. Remove the fasteners from damaged panel.

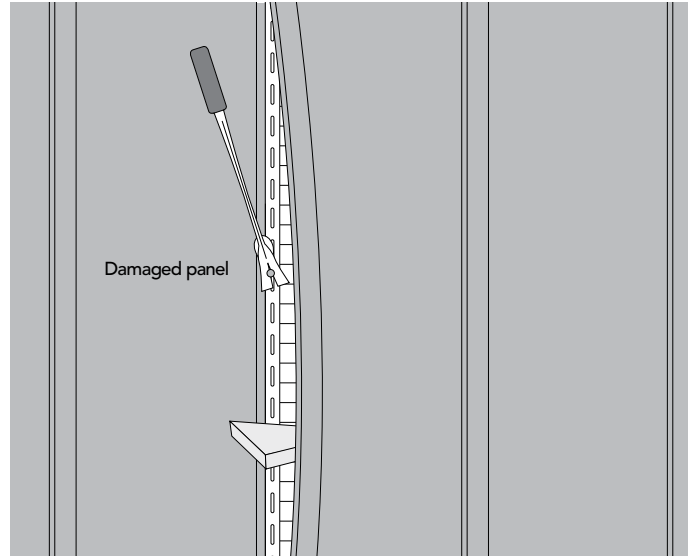

- 3 Unlock and remove the damaged panel.

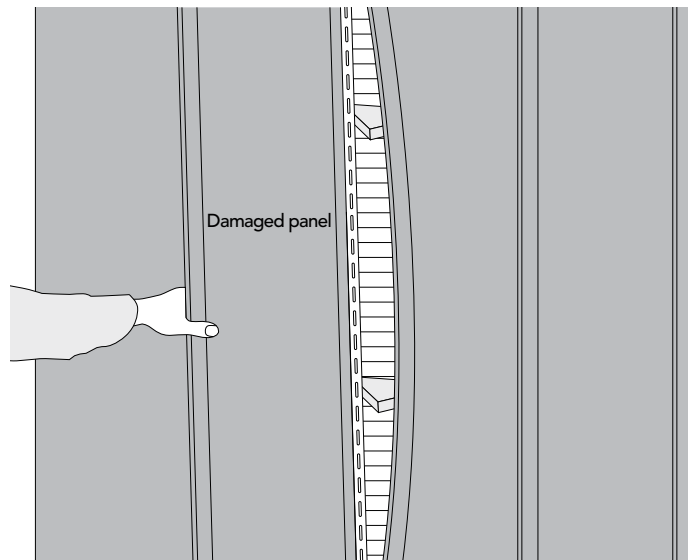

- 4 Install replacement panel and fasten. See "Fastening Procedure: Cladding" section on page 9.

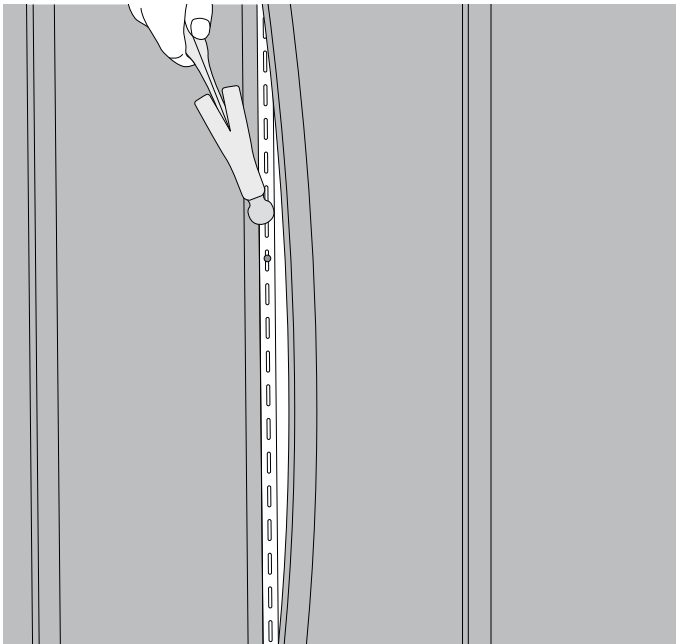
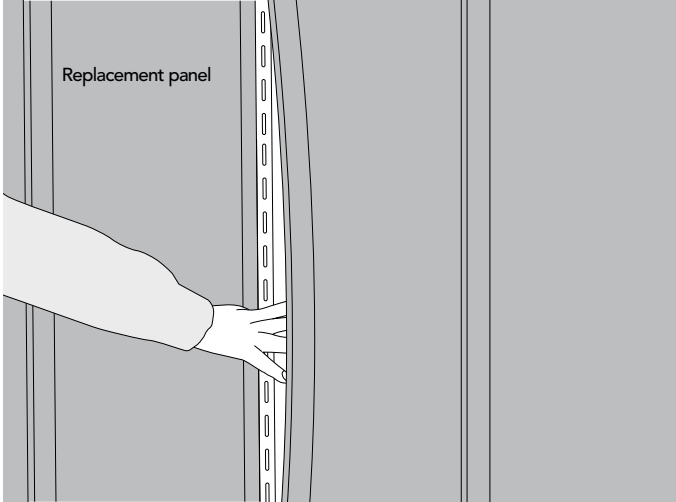

- 5 Remove shims. Use the zip lock tool to lock the panel in place. DO NOT hit or force the panel into place as it may crack the replacement panel lock.

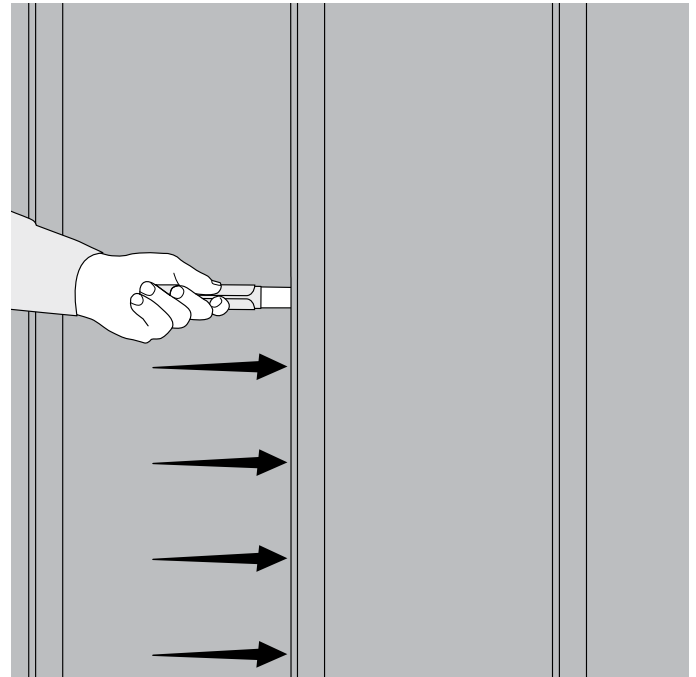

NOTES

Explore more at
ASCENDCompositeCladding.com



ASCENDCompositeCladding.com | 800.922.6009



Please recycle
this literature.